

# FREE-WAY SWITCH

www.froowayswitch.com

MANUFACTURED IN ENGLAND BY NSF CONTROLS LTD



POSITION 4

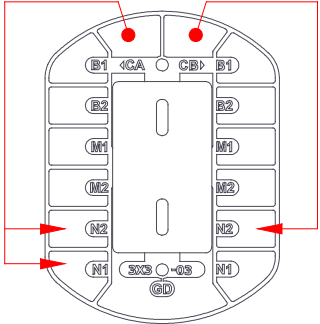

Reverse View of Switch

**ELECTRICAL FUNCTION**  
 Two circuits 'A' & 'B' have commons 'CA' and 'CB' each connecting to: B1, B2, M1, M2, N1, N2 (sometimes in combination) in varying switch positions. A & B side switching differs: 'A' combines B1+B2/N1+N2 'B' isolates B1+B2/N1+N2. 'GD' is 'ground' or 'earth'.

POSITION 1

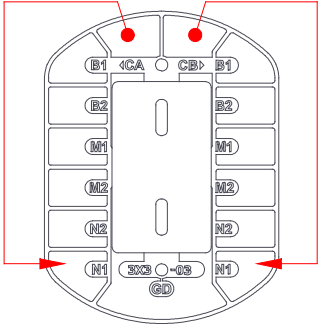

Reverse View of Switch

POSITION 5

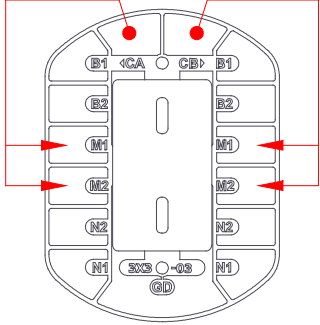

Reverse View of Switch

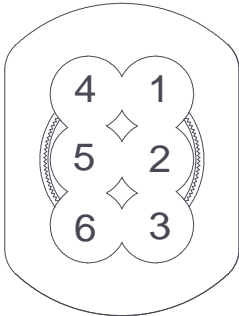

Top View of Switch

POSITION 2

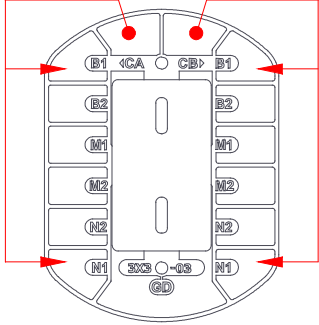

Reverse View of Switch

POSITION 6

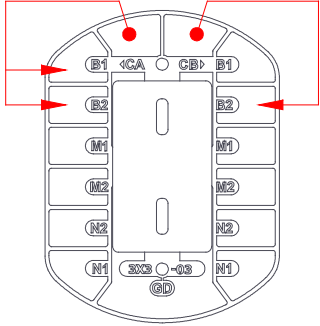

Reverse View of Switch

**ELECTRICAL TRANSITION**  
 'Make Before Break' action in all transitions, except Position 2 to Position 5 where N1 to M2 is 'Break Before Make' on both A & B

POSITION 3

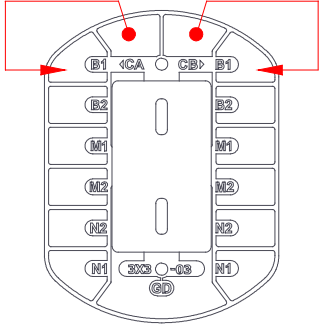

Reverse View of Switch

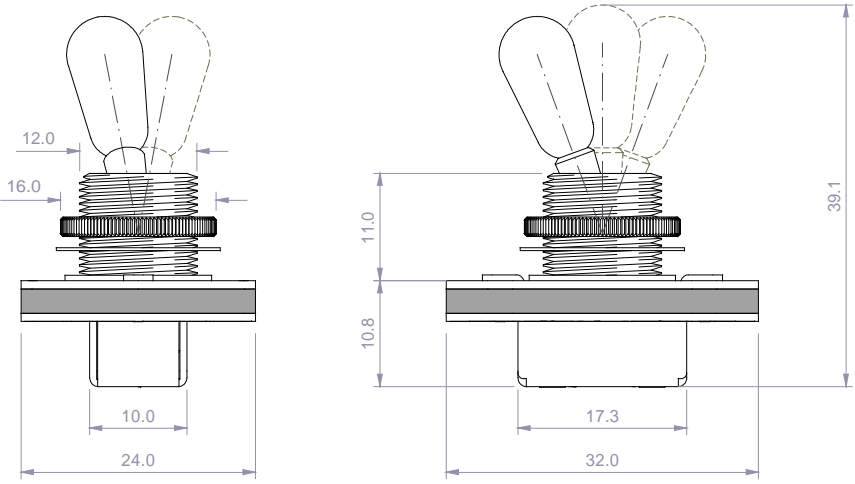

3X3-03 Schematic : Last Updated June 2013